



SERIES 3500

GENERAL ARRANGEMENT

Ref No: 3500.GA.01b
Rev: 1
Date: 20-5-2020

19 Imvubu Road
Sebenza Ext 6
Johannesburg
South Africa

PO Box 1381
Edenvale
South Africa
1610

Tel: 0861 RNE PUMPS
Tel: +27 (11) 452-3528
E-Mail: rne@rnepumps.com
Web: www.rnepumps.com

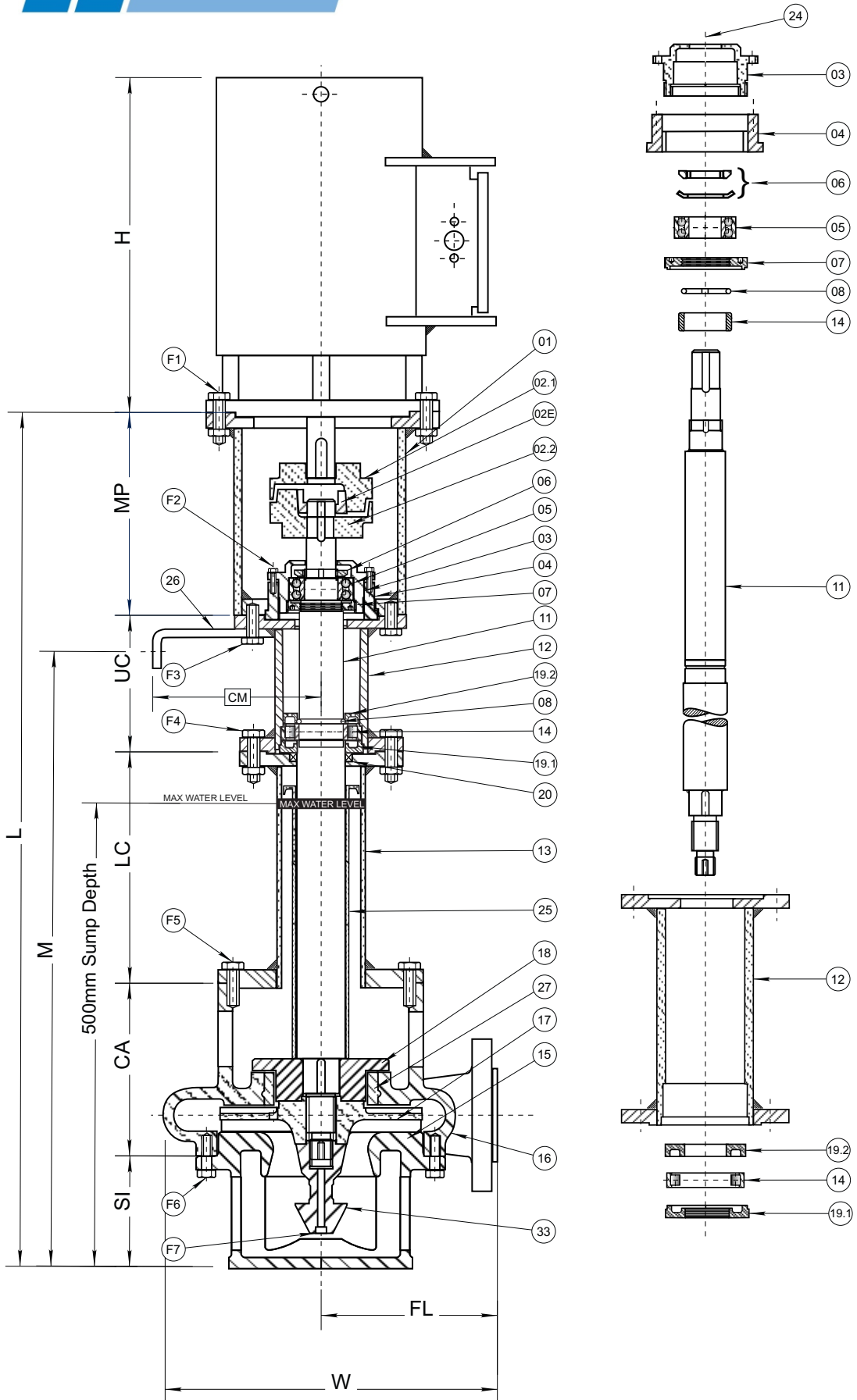

Part No	Description
01	Motor Pedestal
02	Coupling (Complete)
02E	Coupling Element
02.1	Motor Coupling
02.2	Pump Coupling
03	Thrust Bearing Housing
04	Bearing Pedestal
05	Thrust Bearing 6209 E C3 (set)
06	Lock-Nut & Washer
07	Bearing Retaining Ring & Circlip
08	Snap Ring Dia 55 ext.
11	Shaft
12	Upper Column
13	Lower Column
14	Lower Bearing NU211-C3
15	Suction Inlet
16	Casing
17	Impeller
18	Flinger
19.1	Seal Ring (Outer)
19.2	Seal Ring (Inner)
20	Gland Packing
24	Bearing Cartridge Assembly
25	Shaft Sleeve
26	Pump Bracket
27	Casing Insert
33	Agitator or Impeller Lock Nut
Fasteners	
F1	Bolt & Nut: Motor to Motor Pedestal
F2	Bolt: Thrust Brg Housing to Brg Pedestal
F3	Bolt: Motor Pedestal to Upper Column
F4	Bolt & Nut: Upper Column to Lower Column
F5	Bolt: Lower Column to Casing
F6	Bolt: Casing to Suction Inlet
F7	Cap Screw: Agitator to Shaft

